



Zepf Medizintechnik

---



Arthroskopie Instrumente  
Arthroscopy Instruments

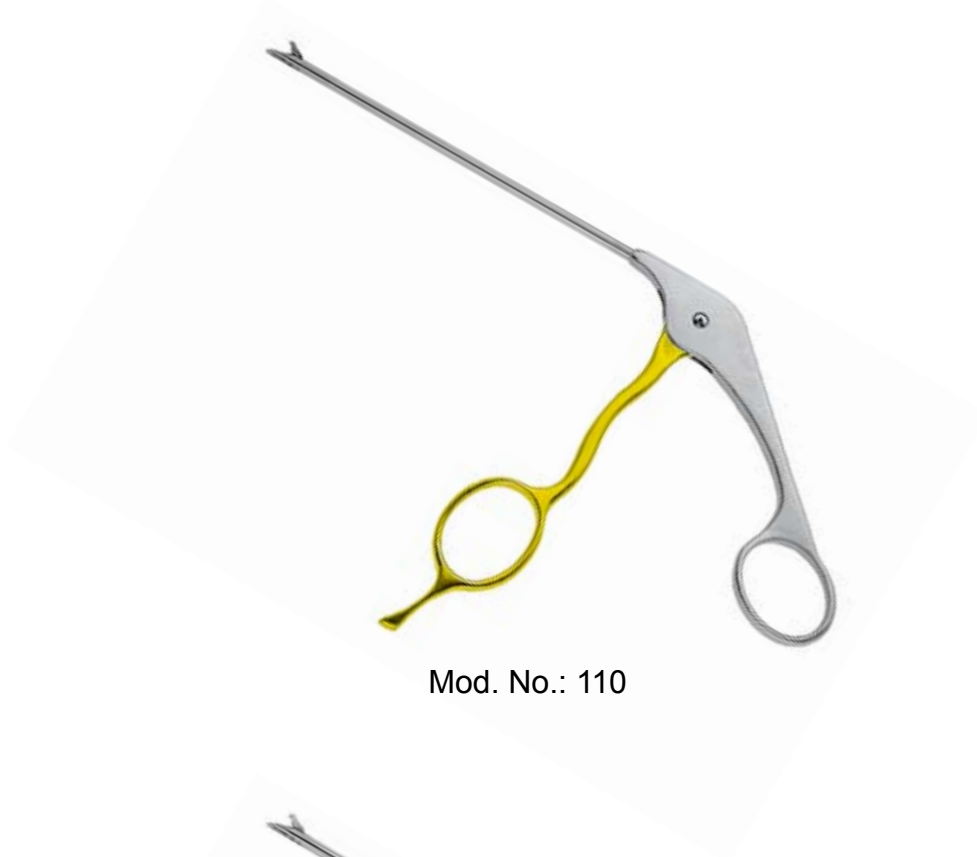

Mod. No.: 110

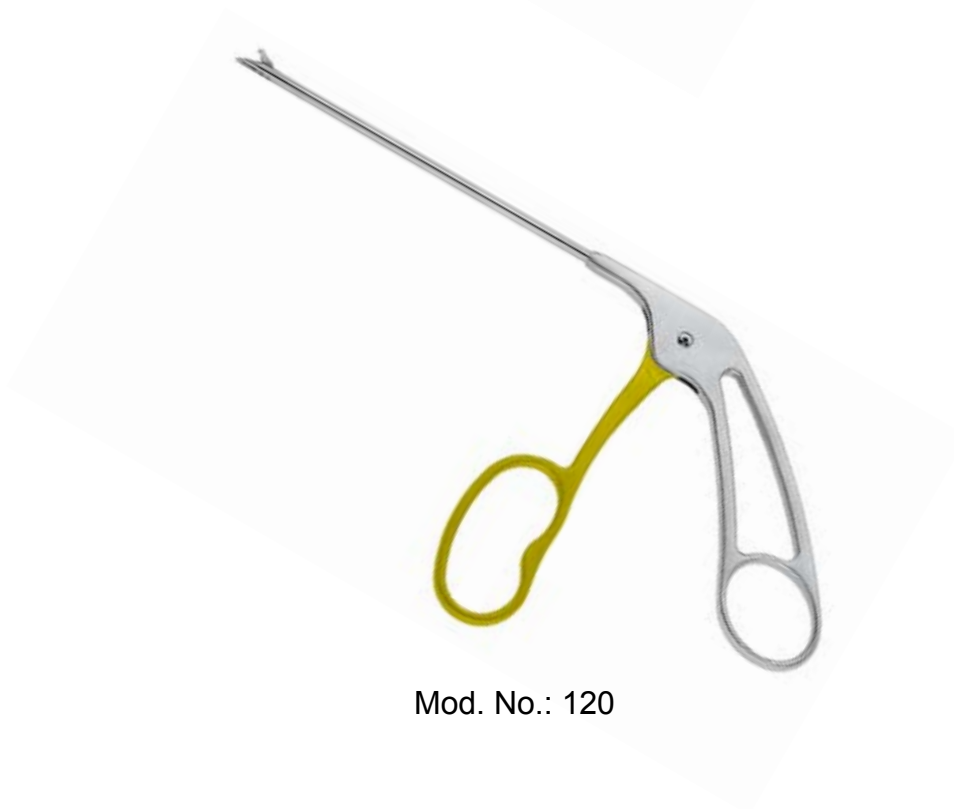

Mod. No.: 120

Diese Broschüre bleibt ausschließlich Eigentum der Firma Martin Zepf Instrumente. Der Nachdruck, auch auszugsweise, ist nicht gestattet. Technische Änderungen und Druckfehler vorbehalten.

This brochure remains exclusive property of the company Martin Zepf Instrumente. Reprinting, even partially, is not allowed. Technical alterations and printing errors reserved.



Mod. No.: 130

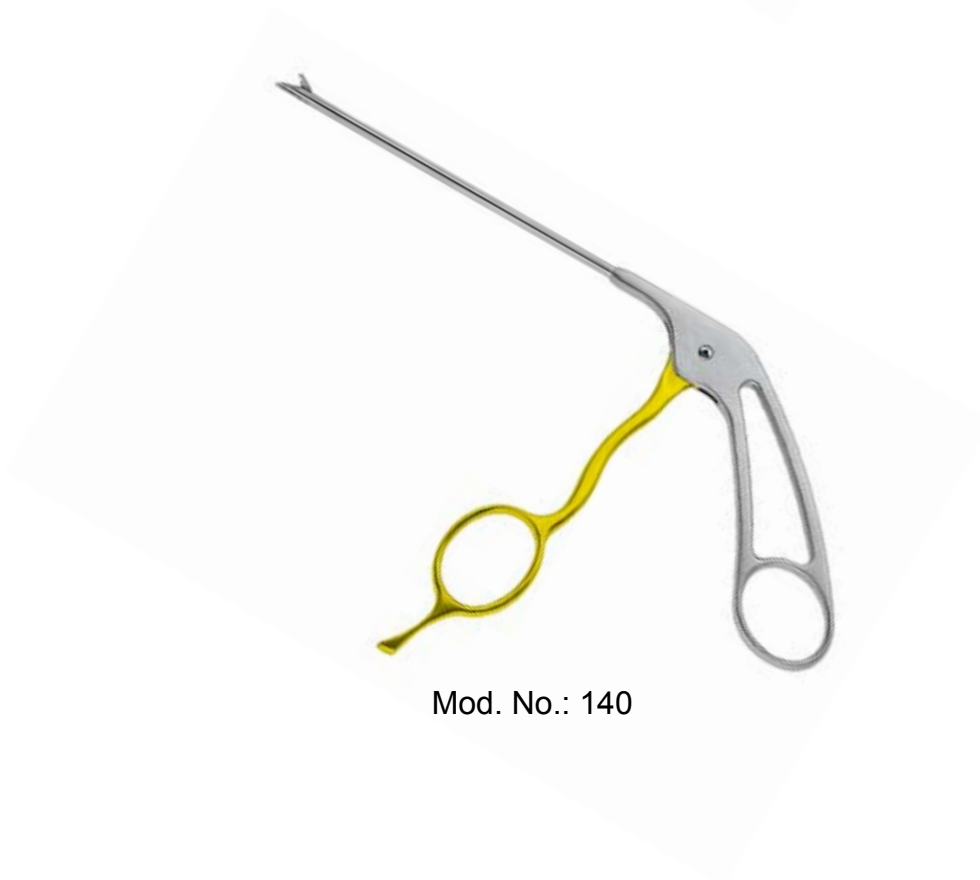

Mod. No.: 140



Mod. No.: 150



Mod. No.: 160





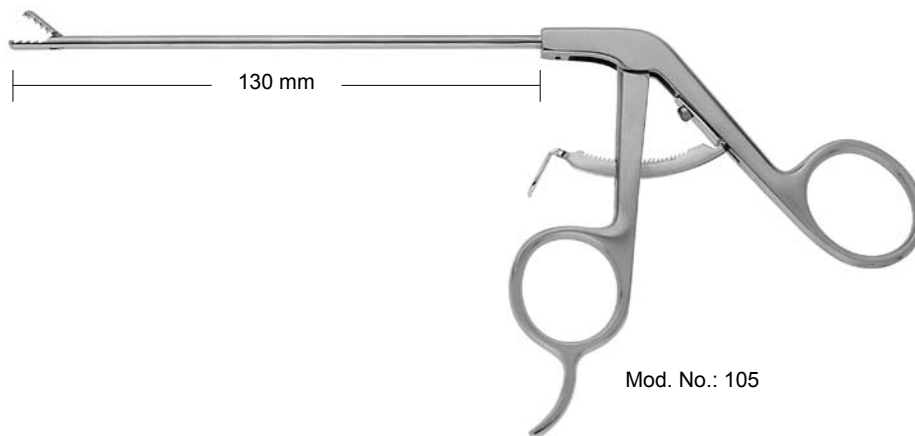
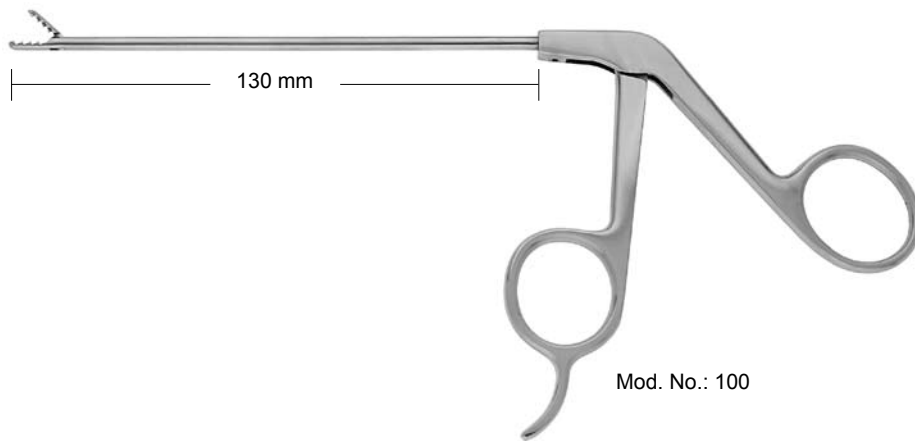







Diese Broschüre bleibt ausschließlich Eigentum der Firma Martin Zepf Instrumente. Der Nachdruck, auch auszugsweise, ist nicht gestattet. Technische Änderungen und Druckfehler vorbehalten.

This brochure remains exclusive property of the company Martin Zepf Instrumente. Reprinting, even partially, is not allowed. Technical alterations and printing errors reserved.



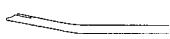

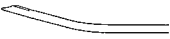









## Arthroskopie / Arthroscopy

Alle Instrumente mit Überlastungsschutz  
All Instruments with Overload Protection

		Hakenschere Hook Scissors	Hakenstanze mit Schaufel Hook Punch with Scoop	Hakenstanze abgesetzt Hook Punch set down	Hakenstanze Schnitt eckig Hook Punch Cut angular
			 L = 5,0 mm · B = 1,6 mm	 L = 5,0 mm · B = 1,6 mm	 L = 5,0 mm · B = 1,6 mm
gerade · straight	2,7	xxx-250-270	xxx-290-270	xxx-350-270	
	3,5	xxx-250-350	xxx-290-350	xxx-350-350	xxx-370-350
30° rechts · 30° right	2,7	xxx-251-270	xxx-291-270	xxx-351-270	
	3,5	xxx-251-350	xxx-291-350	xxx-351-350	xxx-371-350
30° links · 30° left	2,7	xxx-253-270	xxx-293-270	xxx-353-270	
	3,5	xxx-253-350	xxx-293-350	xxx-353-350	xxx-373-350
45° rechts · 45° right	2,7	xxx-255-270	xxx-295-270	xxx-355-270	
	3,5	xxx-255-350	xxx-295-350	xxx-355-350	xxx-375-350
45° links · 45° left	2,7	xxx-257-270	xxx-297-270	xxx-357-270	
	3,5	xxx-257-350	xxx-297-350	xxx-357-350	xxx-377-350
7° auf · 7° up	2,7	xxx-259-270	xxx-299-270	xxx-359-270	
	3,5	xxx-259-350	xxx-299-350	xxx-359-350	xxx-379-350
7° auf · 7° down	2,7	xxx-261-270	xxx-301-270	xxx-361-270	
	3,5	xxx-261-350	xxx-301-350	xxx-361-350	xxx-381-350
15° auf · 15° up	2,7	xxx-263-270	xxx-303-270	xxx-363-270	
	3,5	xxx-263-350	xxx-303-350	xxx-363-350	xxx-383-350
15° auf · 15° down	2,7	xxx-265-270	xxx-305-270	xxx-365-270	
	3,5	xxx-265-350	xxx-305-350	xxx-365-350	xxx-385-350

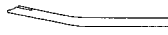









## Arthroskopie / Arthroscopy

Alle Instrumente mit Überlastungsschutz  
All Instruments with Overload Protection



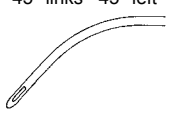
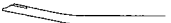

		<b>Hakenstanze 15° aufwärts gefräst Hook Punch 15° up milled</b>  L = 5,0 mm · B = 1,6 mm	<b>Breitmaulstanze groß Wide Jaw Punch large</b>  L = 5,0 mm · B = 4,5 mm	<b>Breitmaulstanze mittel Wide Jaw Punch medium</b>  L = 5,0 mm · B = 3,5 mm	<b>Breitmaulstanze klein Wide Jaw Punch small</b>  L = 6,0 mm · B = 2,5 mm
gerade · straight 	2,7	xxx-390-270			
	3,5	xxx-390-350	xxx-490-350	xxx-560-350	xxx-630-350
30° rechts · 30° right 	2,7	xxx-391-270			
	3,5	xxx-391-350	xxx-491-350	xxx-561-350	xxx-631-350
30° links · 30° left 	2,7	xxx-393-270			
	3,5	xxx-393-350	xxx-493-350	xxx-563-350	xxx-633-350
45° rechts · 45° right 	2,7	xxx-395-270			
	3,5	xxx-395-350	xxx-495-350	xxx-565-350	xxx-635-350
45° links · 45° left 	2,7	xxx-397-270			
	3,5	xxx-397-350	xxx-497-350	xxx-567-350	xxx-637-350
7° auf · 7° up 	2,7	xxx-399-270			
	3,5	xxx-399-350	xxx-499-350	xxx-569-350	xxx-639-350
7° auf · 7° down 	2,7	xxx-401-270			
	3,5	xxx-401-350	xxx-501-350	xxx-571-350	xxx-641-350
15° auf · 15° up 	2,7	xxx-403-270			
	3,5	xxx-403-350	xxx-503-350	xxx-573-350	xxx-643-350
15° auf · 15° down 	2,7	xxx-405-270			
	3,5	xxx-405-350	xxx-505-350	xxx-575-350	xxx-645-350

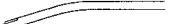

## Arthroskopie / Arthroscopy

Alle Instrumente mit Überlastungsschutz  
All Instruments with Overload Protection

		<b>Breitmaulstanze groß</b> <b>15° aufwärts gefräst</b> <b>Wide Jaw Punch large</b> <b>15° up milled</b>  L = 5,0 mm · B = 4,5 mm	<b>Breitmaulstanze mittel</b> <b>15° aufwärts gefräst</b> <b>Wide Jaw Punch medium</b> <b>15° up milled</b>  L = 5,0 mm · B = 3,5 mm	<b>Breitmaulstanze klein</b> <b>15° aufwärts gefräst</b> <b>Wide Jaw Punch small</b> <b>15° up milled</b>  L = 6,0 mm · B = 2,5 mm	<b>Breitmaulstanze klein</b> <b>45° aufwärts gefräst</b> <b>Wide Jaw Punch small</b> <b>45° up milled</b>  L = 6,0 mm · B = 2,0 mm
gerade · straight 	3,5	xxx-530-350	xxx-600-350	xxx-680-350	xxx-698-350
30° rechts · 30° right 	3,5	xxx-531-350	xxx-601-350	xxx-681-350	
30° links · 30° left 	3,5	xxx-533-350	xxx-603-350	xxx-683-350	
45° rechts · 45° right 	3,5	xxx-535-350	xxx-605-350	xxx-385-350	
45° links · 45° left 	3,5	xxx-537-350	xxx-607-350	xxx-687-350	
7° auf · 7° up 	3,5	xxx-539-350	xxx-609-350	xxx-689-350	
7° auf · 7° down 	3,5	xxx-541-350	xxx-611-350	xxx-691-350	
15° auf · 15° up 	3,5	xxx-543-350	xxx-613-350	xxx-693-350	
15° auf · 15° down 	3,5	xxx-545-350	xxx-615-350	xxx-695-350	













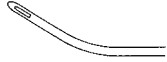

		<b>45° Hakenstanze</b> <b>45° Hook Scissors</b> 	<b>45° Stanze mit Schaufel</b> <b>45° Punch with Scoop</b>  L = 4,5 mm · B = 1,6 mm	<b>45° Stanze stumpf</b> <b>45° Punch blunt</b>  L = 4,5 mm · B = 1,6 mm	<b>90° Stanze mit Schaufel</b> <b>90° Punch with Scoop</b>  L = 4,5 mm · B = 1,6 mm	<b>90° Stanze stumpf</b> <b>90° Punch blunt</b>  L = 4,5 mm · B = 1,6 mm
rechts abgewinkelt right angled	3,5	xxx-270-350	xxx-410-350	xxx-420-350	xxx-450-350	xxx-460-350
links abgewinkelt right angled	3,5	xxx-280-350	xxx-430-350	xxx-440-350	xxx-470-350	xxx-480-350

		<b>90° Breitmaulstanze mittel</b> <b>90° Wide Jaw Punch medium</b>  L = 7,0 mm · B = 3,0 mm	<b>90° Breitmaulstanze klein</b> <b>90° Wide Jaw Punch small</b>  L = 7,0 mm · B = 1,8 mm
rechts abgewinkelt right angled	3,5	xxx-740-350	xxx-760-350
links abgewinkelt right angled	3,5	xxx-750-350	xxx-770-350

## Arthroskopie / Arthroscopy

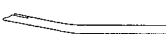

Alle Instrumente mit Überlastungsschutz  
All Instruments with Overload Protection





		<b>Scherenstanze</b> <b>Scissors Punch</b>  L = 5,0 mm · B = 0,8 mm	<b>Scherenstanze</b> <b>15° aufwärts gefräst</b> <b>Scissors Punch</b> <b>15° up milled</b>  L = 5,0 mm · B = 0,8 mm	<b>Stanze Retrograd</b> <b>Schnitt links</b> <b>Punch Retrograde</b> <b>Cut left</b>  L = 4,0 mm · B = 2,5 mm	<b>Stanze Retrograd</b> <b>Schnitt rechts</b> <b>Punch Retrograde</b> <b>Cut right</b>  L = 4,0 mm · B = 2,5 mm
gerade · straight 	3,5	xxx-700-350	xxx-720-350	xxx-780-350	xxx-790-350
30° rechts · 30° right 	3,5	xxx-701-350	xxx-721-350		
30° links · 30° left 	3,5	xxx-703-350	xxx-723-350		
45° rechts · 45° right 	3,5	xxx-705-350	xxx-725-350		
45° links · 45° left 	3,5	xxx-707-350	xxx-727-350		
7° auf · 7° up 	3,5	xxx-709-350	xxx-729-350		
7° auf · 7° down 	3,5	xxx-711-350	xxx-731-350		
15° auf · 15° up 	3,5	xxx-713-350	xxx-733-350		
15° auf · 15° down 	3,5	xxx-715-350	xxx-735-350		

## Arthroskopie / Arthroscopy





Alle Instrumente mit Überlastungsschutz  
All Instruments with Overload Protection

		<b>Fasszange</b> <b>Grasping Forceps</b>	<b>Fasszange</b> <b>1 x 2 Zähne, fein</b> <b>Grasping Forceps</b> <b>1 x 2 Teeth, fine</b>	<b>Fasszange</b> <b>1 x 2 Zähne, grob</b> <b>Grasping Forceps</b> <b>1 x 2 Teeth, crass</b>
				
	2,7	xxx-800-270		
	3,5	xxx-800-350	xxx-820-350	xxx-840-350

		<b>Fass- und</b> <b>Biopsiezange</b> <b>Grasping and</b> <b>Biopsy Forceps</b>	<b>Biopsie-Löffel-</b> <b>Zange</b> <b>Biopsy Spoon</b> <b>Forceps</b>	<b>Bulldog -Fasszange</b> <b>1x2 Zähne, grob</b> <b>Bulldog -Grasping</b> <b>Forceps</b> <b>1x2 teeth, crass</b>
				
	2,7			
	3,5	xxx-860-350	xxx-880-350	
	4,5			xxx-845-350

## Arthroskopie / Arthroscopy

Alle Instrumente mit Überlastungsschutz  
All Instruments with Overload Protection

	<p>Fadenfazzange gerade Suture Grasping Forceps</p> 	<p>Arthro-Stecker 45° scharf aufwärts gefräst Suture-Pierce 45° sharp up milled</p> 	<p>Arthro-Stecker 10° scharf aufwärts gefräst Suture-Pierce 10° sharp up milled</p> 	<p>Arthro-Stecker scharf gerade Suture-Pierce sharp straight</p> 
	xxx-890-350	xxx-893-350	xxx-895-350	xxx-900-350

Sondermodelle auf Anfrage



**500-100-450**

Axiale Fasszange  
Axial Grasping Forceps

gerade · straight

mit Sperre · with ratchet

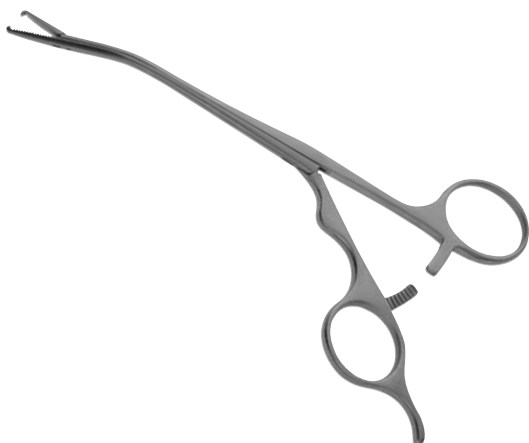

**500-110-450**

Axiale Fasszange  
Axial Grasping Forceps

rechts gebogen · right curved

mit Sperre · with ratchet



**500-120-450**

Axiale Fasszange  
Tendon Grasping Forceps

links gebogen · left curved

mit Sperre · with ratchet

*Alle Modelle auch ohne Sperre möglich  
all instruments without ratchet available*

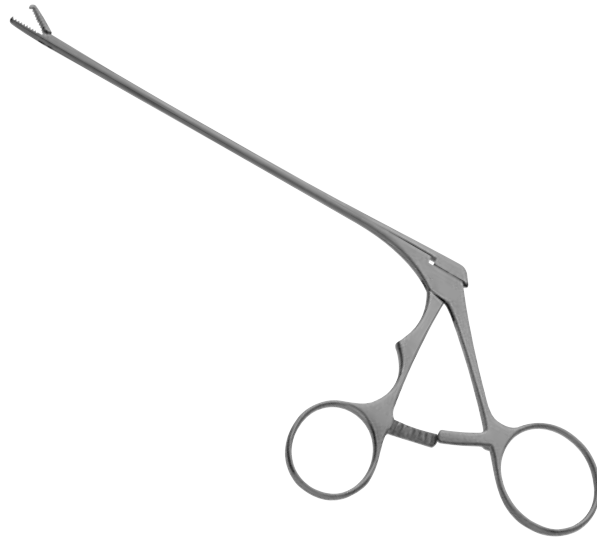

**500-101-455**

Arthroskopie-Fasszange, fein gezahnt  
1x2 Zähne, gerade, Länge 110 mm, Griff mit Sperre

Mini Grasping Forceps 1x2 teeth with ratched



**500-110-455**

Meniskus-Fasszange kräftig, 4,2 mm Ø  
Meniscus grasping forceps, strong, 4,2 mm Ø

## Handinstrumente



**600**  
Griff allein, 125 mm  
Handle only, 125 mm



**601**  
Sonde graduiert, 3,5 mm  
Probe graduated, 3,5 mm



**609**  
Ring-Kürette, 3 mm  
Ring-curette, 3 mm



**602**  
Skalpelmesser  
Scalpel knife



**610**  
Sichelmesser  
Sickle knife



**603**  
Bananamesser glatt  
Banana knife smooth



**611**  
Bajonettmesser  
Bayonet knife



**604**  
Bananamesser gezahnt  
Banana knife toothed



**612**  
Messer, gezahnt, gerade  
Knife, toothed, straight

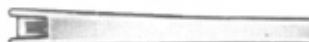

**605**  
Meniskotome, 5 mm gerade Schneide  
Meniscotome, 5 mm straight edge



**613**  
Messer, glatt, gerade  
Knife, smooth, straight



**606**  
Meniskotome, 7 mm runde Schneide  
Meniscotome, 7 mm round edge



**614**  
Messer, gezahnt, gebogen 30°  
Knife, toothed, curved 30°



**607**  
Hakenmesser 90°  
Hook knife 90°



**615**  
Löffel 3 mm gebogen 30°  
Spoon 3 mm curved 30°



**608**  
Messer 45°  
Knife 45°



**616**  
Hakensonde spitz  
Hook probe pointed

## Handinstrumente



**700**  
Griff allein, 125 mm  
Handle only, 125 mm



**701**  
Sonde graduiert, 3,5 mm  
Probe graduated, 3,5 mm



**709**  
Ring-Kürette, 3 mm  
Ring-curette, 3 mm



**702**  
Skalpelmesser  
Scalpel knife



**710**  
Sichelmesser  
Sickle knife



**703**  
Bananamesser glatt  
Banana knife smooth



**711**  
Bajonettmesser  
Bayonet knife



**704**  
Bananamesser gezahnt  
Banana knife toothed



**712**  
Messer, gezahnt, gerade  
Knife, toothed, straight

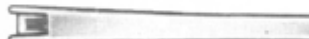

**705**  
Meniskotome, 5 mm gerade Schneide  
Meniscotome, 5 mm straight edge



**713**  
Messer, glatt, gerade  
Knife, smooth, straight



**706**  
Meniskotome, 7 mm runde Schneide  
Meniscotome, 7 mm round edge



**714**  
Messer, gezahnt, gebogen 30°  
Knife, toothed, curved 30°



**707**  
Hakenmesser 90°  
Hook knife 90°



**715**  
Löffel 3 mm gebogen 30°  
Spoon 3 mm curved 30°



**708**  
Messer 45°  
Knife 45°



**716**  
Hakensonde spitz  
Hook probe pointed





1 Hahn starr  
1 stopcock fixed

<b>810</b>	Ø 2,7 mm	Arbeitslänge/Working length	175 mm
<b>820</b>	Ø 4,0 mm	Arbeitslänge/Working length	175 mm

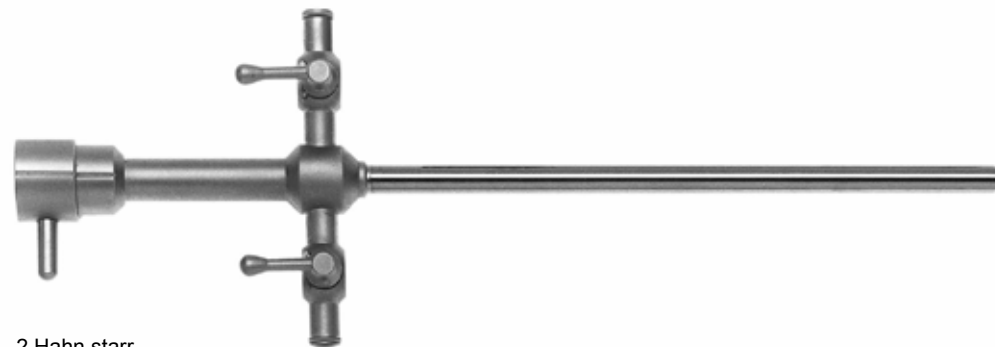

2 Hahn starr  
2 stopcock fixed

<b>830</b>	Ø 2,7 mm	Arbeitslänge/Working length	175 mm
<b>840</b>	Ø 4,0 mm	Arbeitslänge/Working length	175 mm

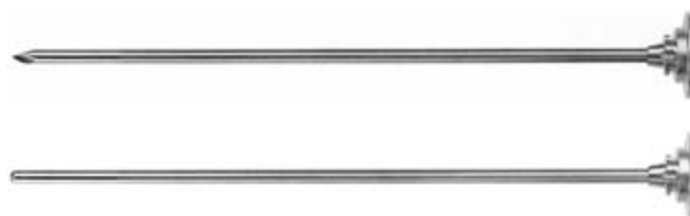

Trokar spitz / pyramidal

<b>850</b>	Ø 2,7 mm	Arbeitslänge/Working length	175 mm
<b>860</b>	Ø 4,0 mm	Arbeitslänge/Working length	175 mm

Obturator stumpf / blunt

<b>870</b>	Ø 2,7 mm	Arbeitslänge/Working length	175 mm
<b>880</b>	Ø 4,0 mm	Arbeitslänge/Working length	175 mm



1 Hahn drehbar  
1 stopcock rotatable

<b>890</b>	Ø 2,7 mm	Arbeitslänge/Working length	175 mm
<b>900</b>	Ø 4,0 mm	Arbeitslänge/Working length	175 mm

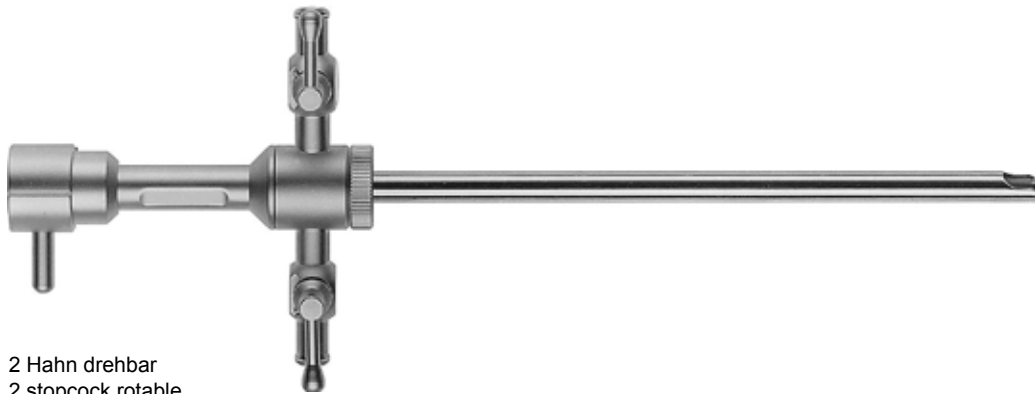

2 Hahn drehbar  
2 stopcock rotatable

<b>910</b>	Ø 2,7 mm	Arbeitslänge/Working length	175 mm
<b>920</b>	Ø 4,0 mm	Arbeitslänge/Working length	175 mm

**Arthroskopieelektroden, wiederverwendbar, 4 mm, autoklavierbar 134°C**  
**Arthroscopic electrodes, reusable, 4 mm, autoclavable 134°C**



**1000**

HF Handgriff für 4 mm Schaft - Elektroden Berchtold kompatibel  
 HF pencil for 4 mm shaft - electrodes Erbe Martin compatible

**2000**

HF Handgriff für 4 mm Schaft - Elektroden Erbe Martin kompatibel  
 HF pencil for 4 mm shaft - electrodes Erbe Martin compatible



**101**

Nadelelektrode, 90° abgewinkelt, 1,5 mm, NL 115 mm, Ø 6 mm  
 Needle electrode, 90° angled, 1,5 mm, WL 115 mm, Ø 6 mm



**102**

Nadelelektrode, 90° abgewinkelt, 4 mm, NL 115 mm, Ø 6 mm  
 Needle electrode, 90° angled, 4 mm, WL 115 mm, Ø 6 mm



**103**

Tastelektrode, 90° abgewinkelt, 4 mm, NL 115 mm, Ø 1,5 mm  
 Button electrode, 90° angled, 4 mm, WL 115 mm, Ø 1,5 mm



**104**

Kugелеlektrode, NL 115 mm, Ø 3 mm  
 Ball electrode, WL 115 mm, Ø 3 mm

**Arthroskopieelektroden, wiederverwendbar, 4 mm, autoklavierbar 134°C**  
**Arthroscopic electrodes, reusable, 4 mm, autoclavable 134°C**



**105**  
Nadelelektrode mit Handgriff, 90° abgewinkelt, 1,5 mm, Länge 115 mm, Ø 0,6 mm  
Needle electrode with handle, 90° angled, 1,5 mm, length 115 mm, Ø 0,6 mm



**106**  
Nadelelektrode mit Handgriff, 90° abgewinkelt, 4 mm, Länge 115 mm, Ø 0,6 mm  
Needle electrode with handle, 90° angled, 4 mm, length 115 mm, Ø 0,6 mm



**107**  
Tastenelektrode mit Handgriff, 90° abgewinkelt, 4 mm, Länge 115 mm, Ø 1,5 mm  
Button electrode with handle, 90° angled, 4 mm, length 115 mm, Ø 1,5 mm



**108**  
Kugelelektrode mit Handgriff, Länge 115 mm, Ø 3 mm  
Ball electrode with handle, length 115 mm, Ø 3 mm

**Bipolar Arthroskopieelektroden, wiederverwendbar, autoklavierbar 134°C**  
**Bipolar arthroscopic electrodes, reusable, autoclavable 134°C**



**109**  
Bipolar-Nadelelektrode, 90° abgewinkelt, 1,5 mm, Länge 115 mm, Ø 0,6 mm  
Bipolar-Needle electrode, 90° angled, 1,5 mm, length 115 mm, Ø 0,6 mm



**110**  
Bipolar-Nadelelektrode, 90° abgewinkelt, 4 mm, Länge 115 mm, Ø 0,6 mm  
Bipolar-Needle electrode, 90° angled, 4 mm, length 115 mm, Ø 0,6 mm



**111**  
Bipolar-Tastelektrode, 90° abgewinkelt, 4 mm, Länge 115 mm, Ø 1,5 mm  
Bipolar-Button electrode, 90° angled, 4 mm, length 115 mm, Ø 1,5 mm



**112**  
Bipolar-Kugelektrode, Länge 115 mm, Ø 3 mm  
Bipolar-Ball electrode, length 115 mm, Ø 3 mm







**Zepf Medizintechnik**

---

Zepf Medizintechnik · Schloßstr. 9 · 78573 Wurmlingen · Germany  
Tel.: +49 7461-8328 · Fax: +49 7461-5397  
E-Mail: [ZM.Medizintechnik@GMX.de](mailto:ZM.Medizintechnik@GMX.de)